

PULSE FIRING BASICS

Presented By:

Paul Palkovic

Elster-Kromschroder



elster
Kromschöder



What is Pulse Firing?

- Pulse firing is a specialized type of combustion system control that offers significant process and productivity benefits.
 - Fuel Savings
 - Improved Temperature Uniformity
 - Lower NOx emissions
 - Versatile control scheme
 - Improved turndown
 - Suitable for heating and cooling cycles



Pulse Firing



Fuel Savings

- Pulse firing operates burners close to ratio at their most efficient firing setting (high fire) creating ideal operating conditions that result in maximum heat transfer with minimal fuel input.

Improved Temperature Uniformity

- High velocity burners produce maximum heat transfer to the load within the furnace chamber.

Lower Emissions

- NOx emissions are minimized as the high velocity flame entrains the maximum amount of furnace gases for more complete mixing and lower peak flame temperatures.





Pulse Firing

Control Design Flexibility

- Pulse fired systems can be designed to accommodate even the most stringent temperature uniformity and application requirements
- Maximum system turndown can be achieved whether your furnace hold temperature is 800°F or 2300°F

Maximized Productivity

- Pulse firing utilizes the system's burners at their most efficient firing rates – transferring maximum energy to the furnace load in the least amount of time



High Velocity Burners



A Key Component in a pulse fired system is high velocity burners.

- High velocity – about 25,000 ft/min exit velocity
- Best combustion mixing for efficiency and lowest flue gas emissions
- Best flame shape for heat release (largest area)
- Highest velocity when burner is on high fire
- Entrain many times its own volume in furnace gases -This stirs the furnace atmosphere and promotes temperature uniformity



Entrainment in a Tunnel Kiln

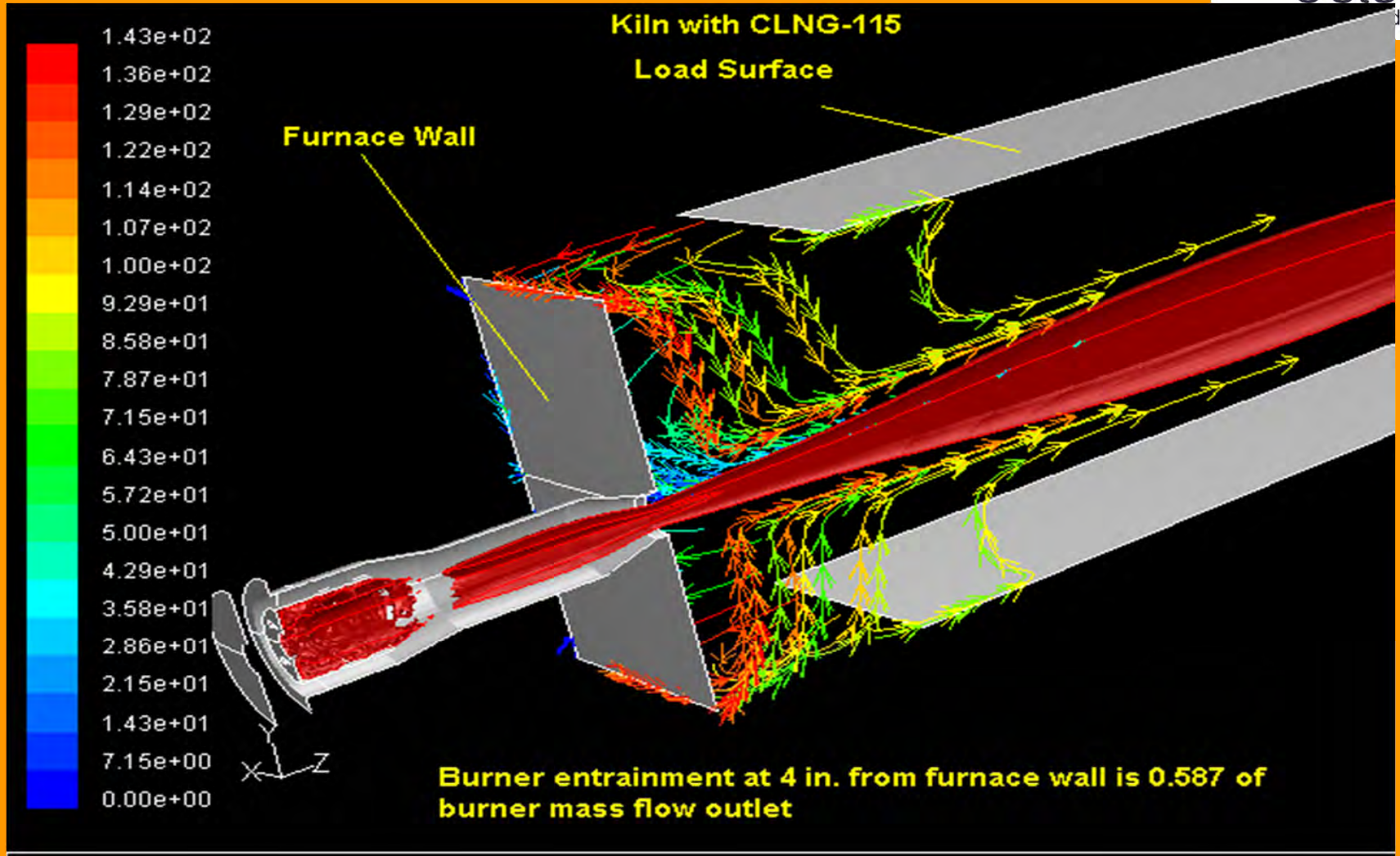

Path Lines Colored by Particle ID

Jun 02, 2004
FLUENT 6.1 (3d, segregated, spe5, ske)



Can the burner stay at high fire at all times?



- No – When the furnace conditions call for less heat input, the burner system must turn down to a lower heat input.
- There are three typical methods of turning a burner down or controlling the firing rate.
 - Fuel only/Excess air control
 - Cross Connected/Ratio Control
 - Pulse Firing



Fuel-Only / Excess Air Control

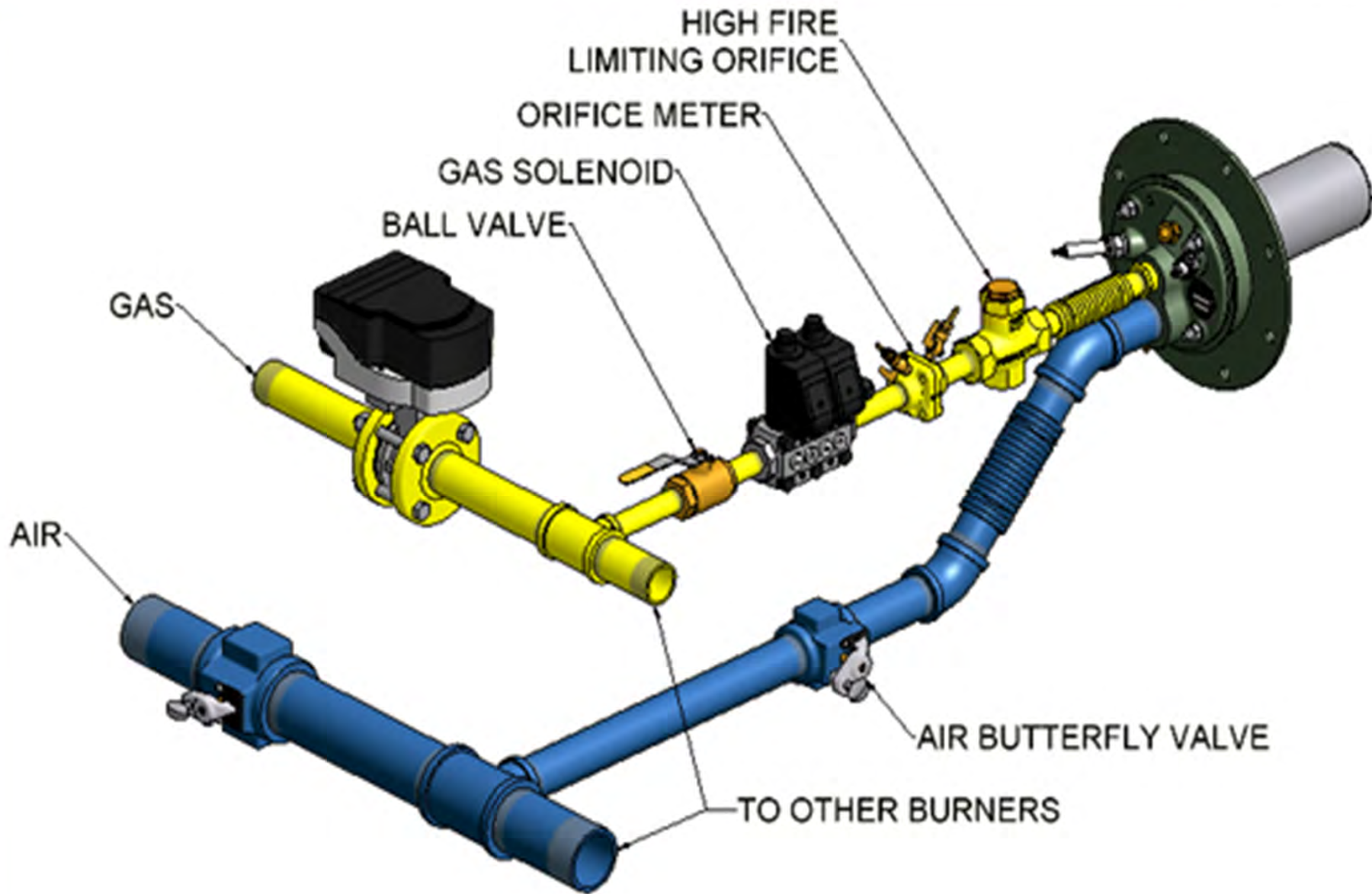

Cross Connected/Modulated/Ratio Control

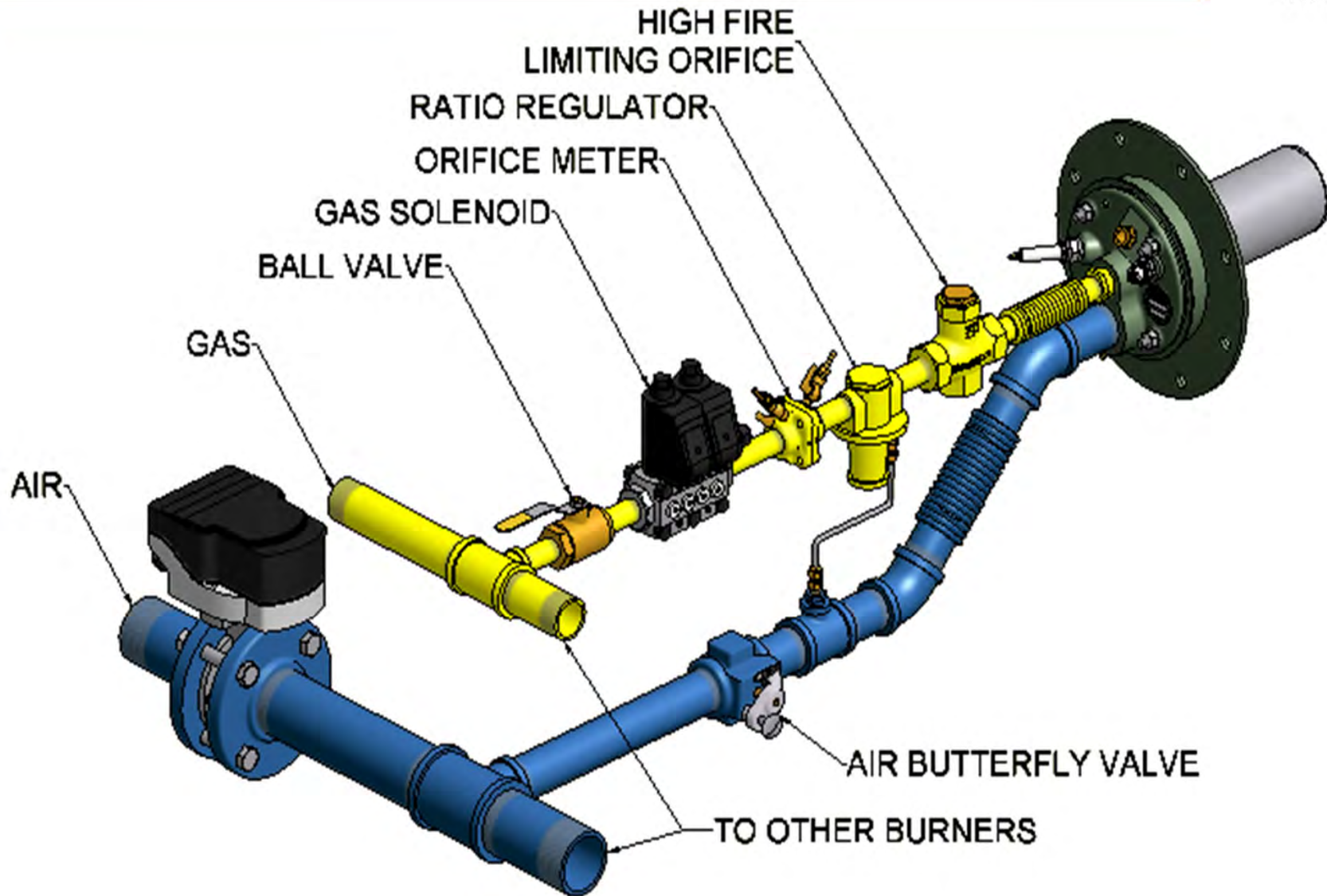

Pulse Fire Control

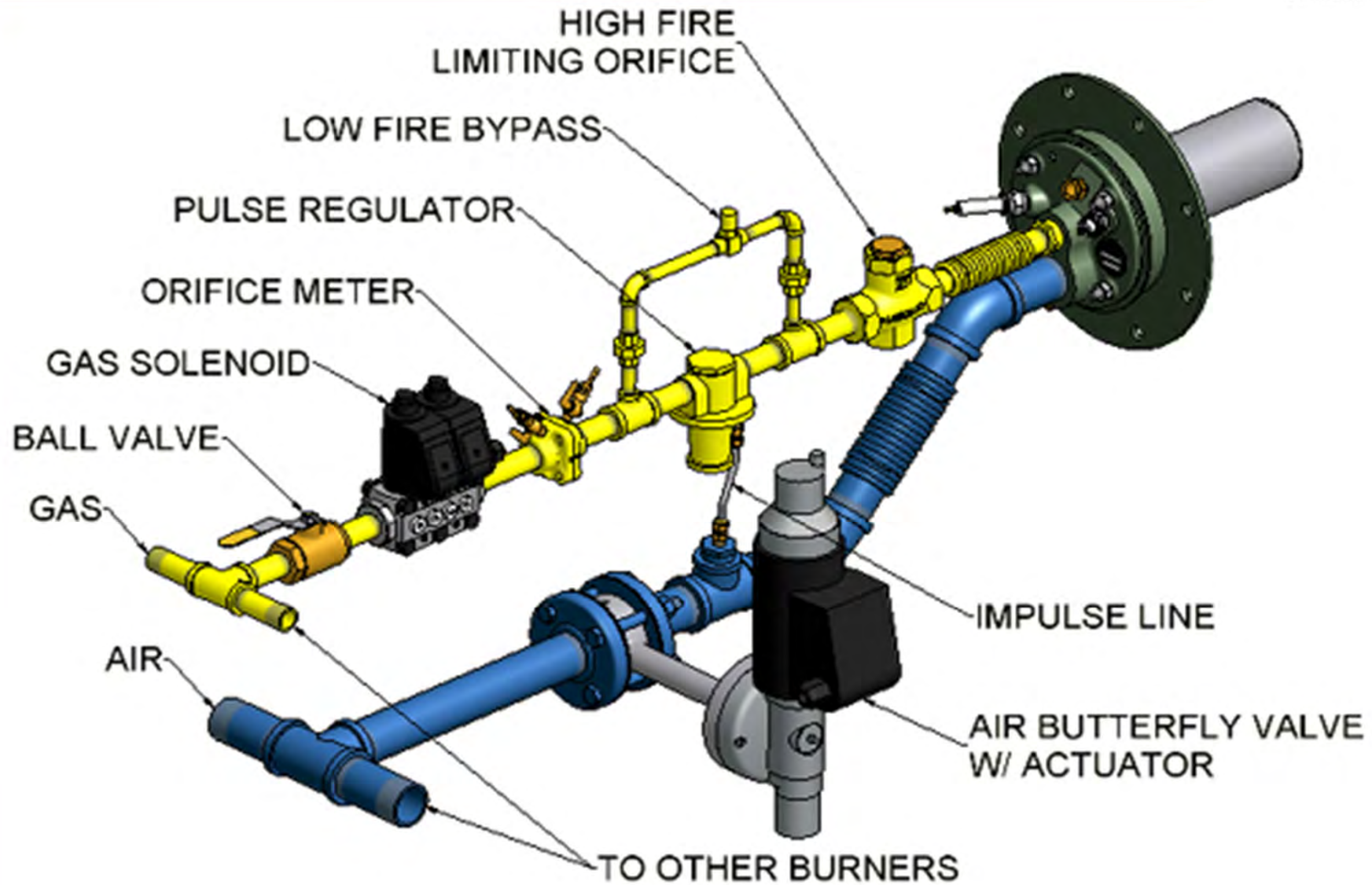

Pulse Firing

- Pulse firing controls thermal input by cycling burners from high to low or high-off to meet the application's required heat demand.
- An air solenoid valve at each burner with adjustable minimum and maximum settings replaces the typical modulating air valve.
- Low fire is set by a bypass in or around the pulse regulator



Pulse Firing

- The burner is ignited at low fire.
- Each time the solenoid is energized, the burner switches from low fire to high fire operation.
- This uses the entrainment and stirring action of high velocity burners to their best advantage.
- Air and gas piping to each burner is identical.
- Changing the pulsing sequence or moving a burner from one zone to another can be done electronically – which simplifies air and gas piping requirements

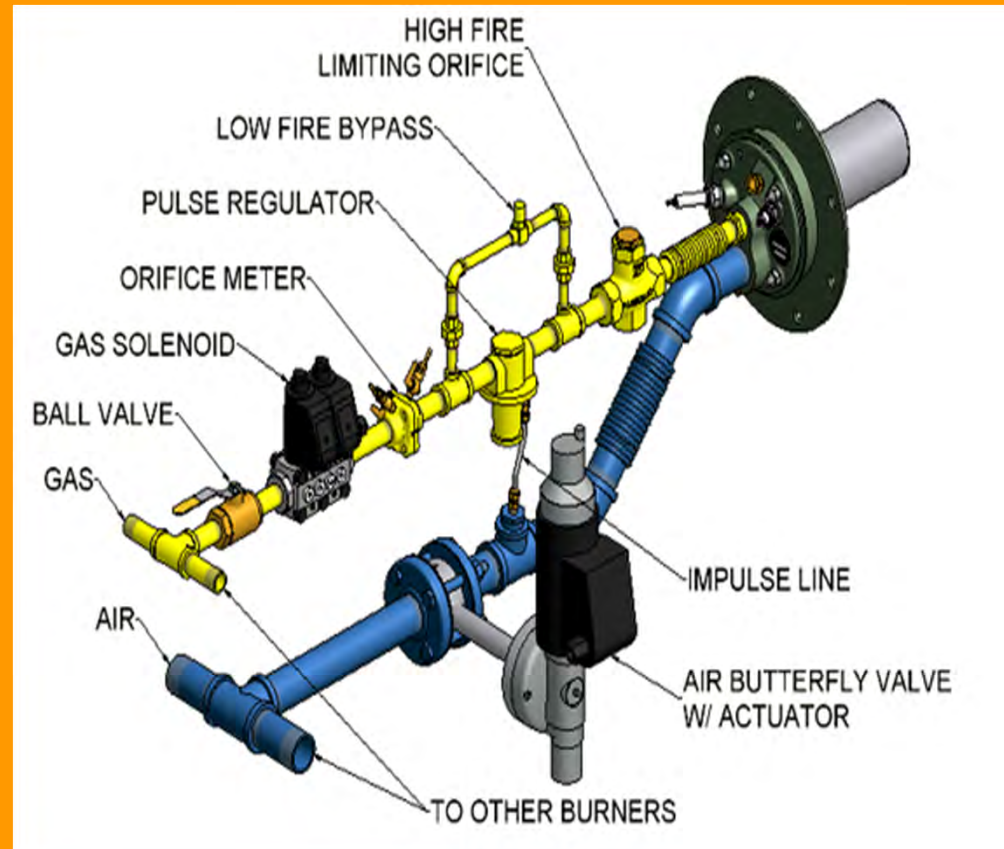

Real World Pulse Firing Application



Pulse Firing Control



Pulse firing converts an analog heat demand signal to a digital firing sequence.

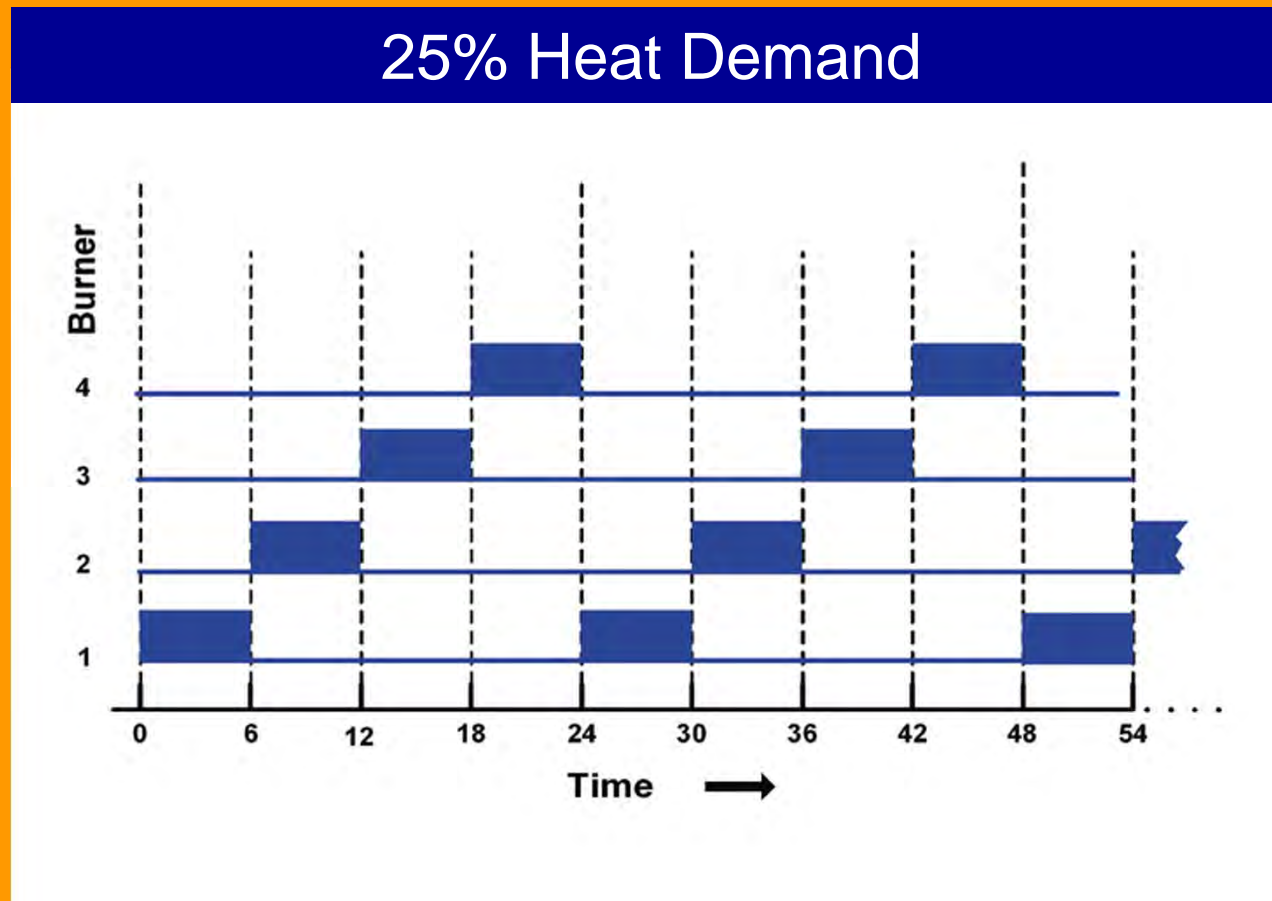

Pulse Firing Control



Pulse firing converts an analog heat demand signal to a digital firing sequence.

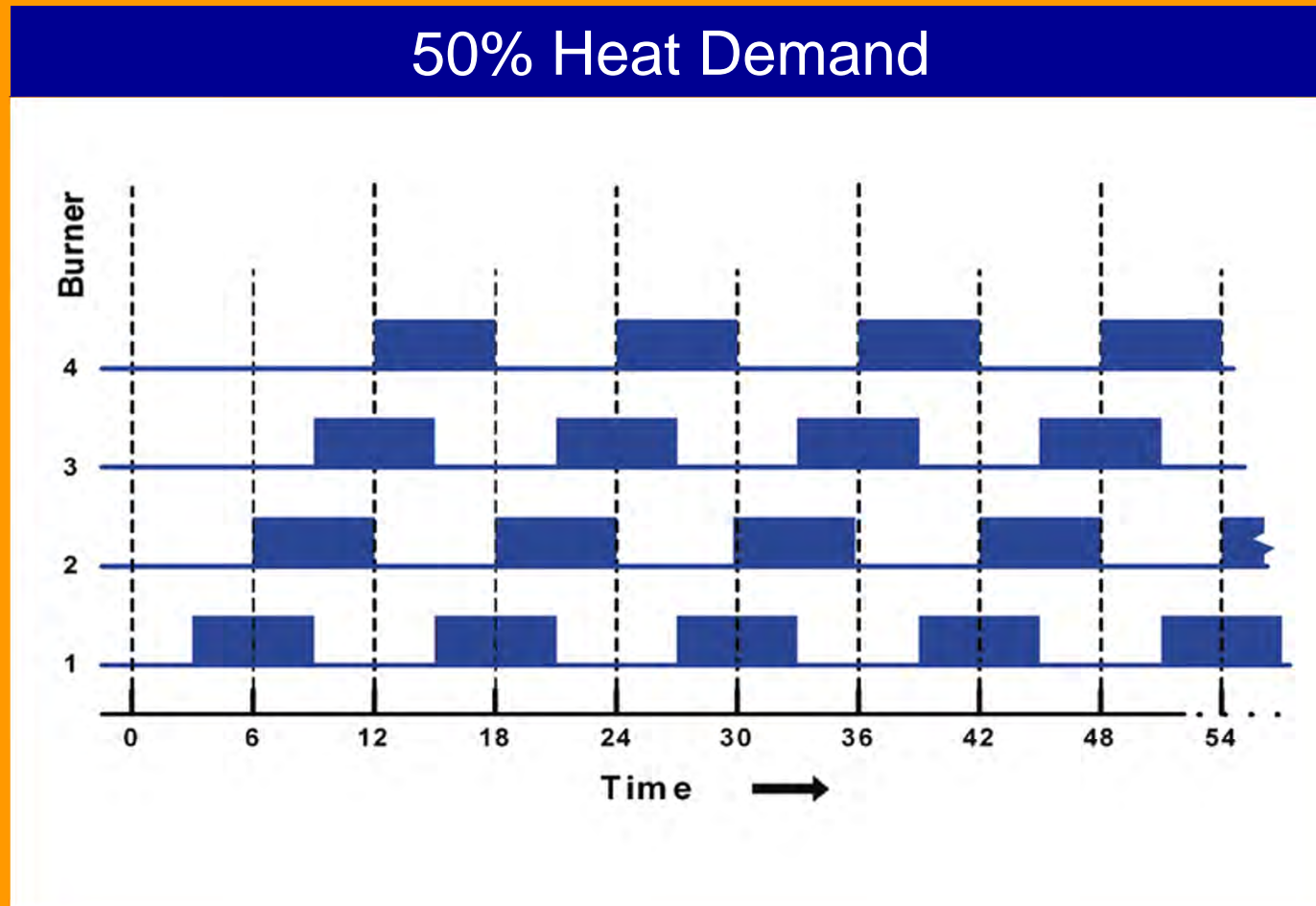

Pulse Firing Changes Gas Flow Path to the Flues

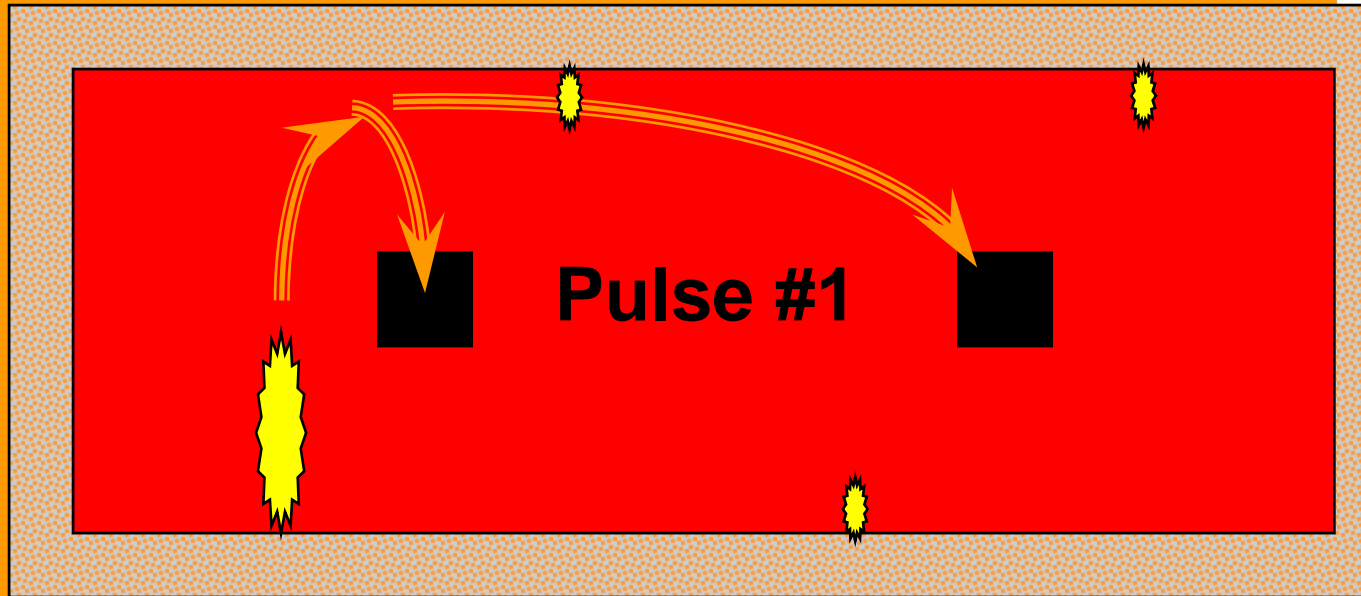

33% firing rate

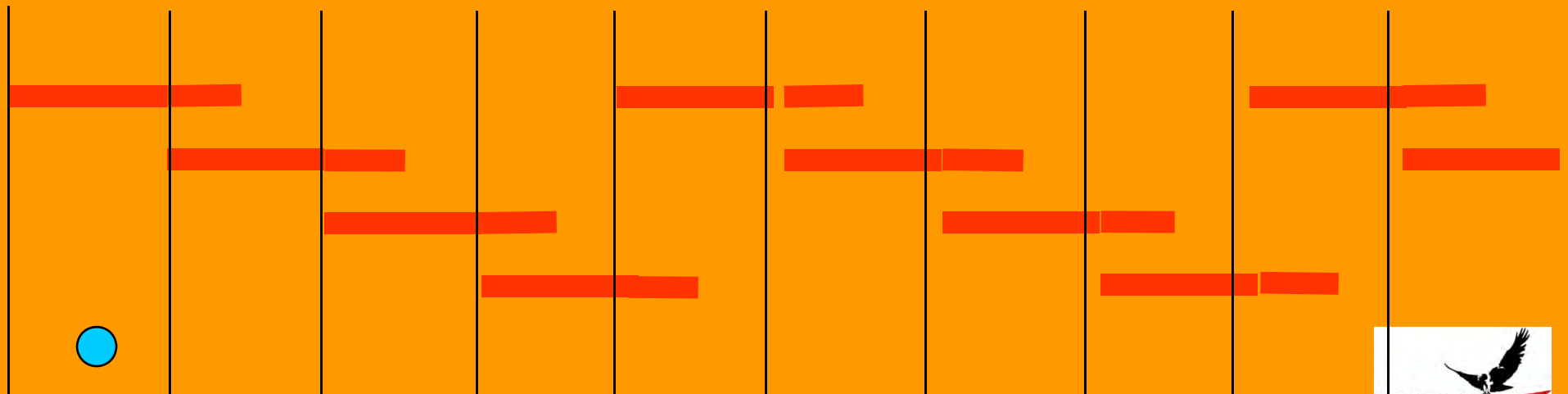

Pulse Firing Changing Flow Path to the Flues

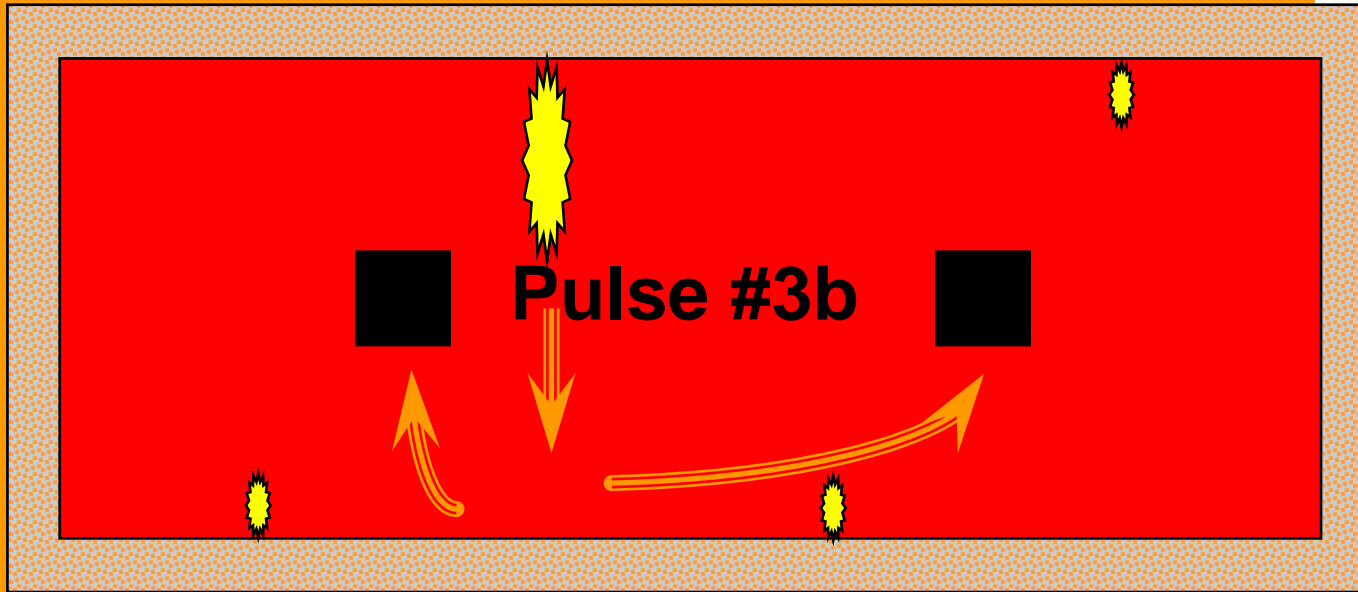

33% firing rate

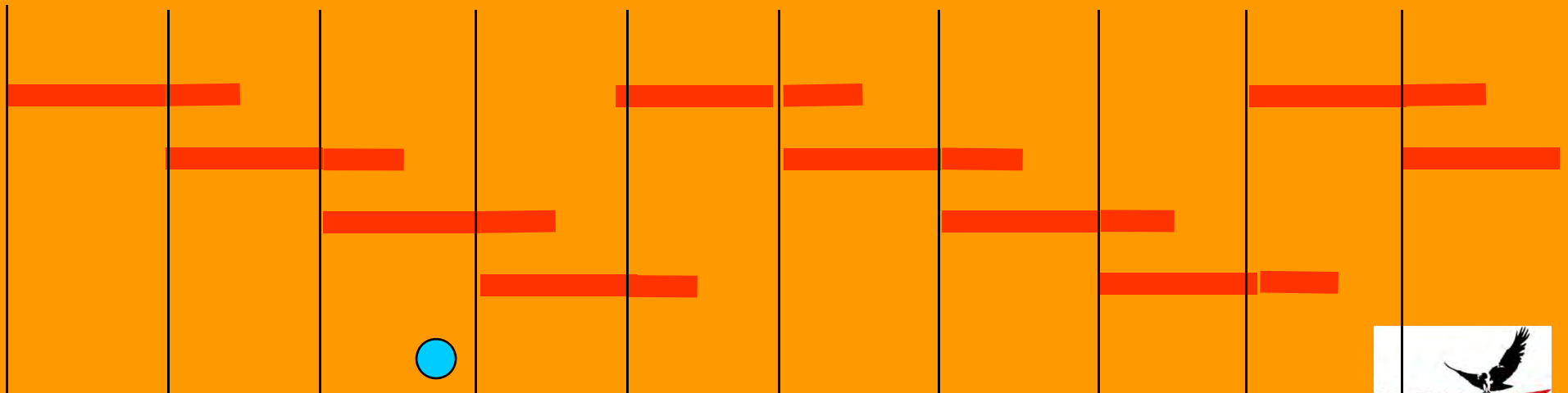

Pulse Firing Changing Flow Path to the Flues

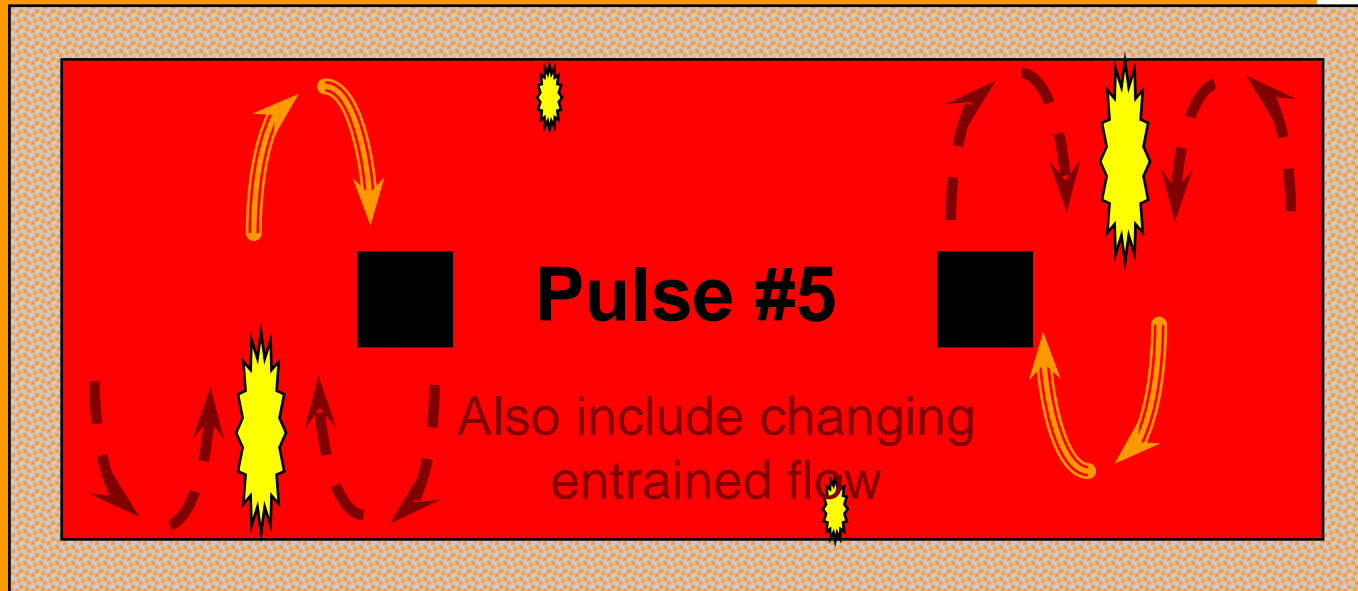

At least 8 flow path changes every minute

33% firing rate

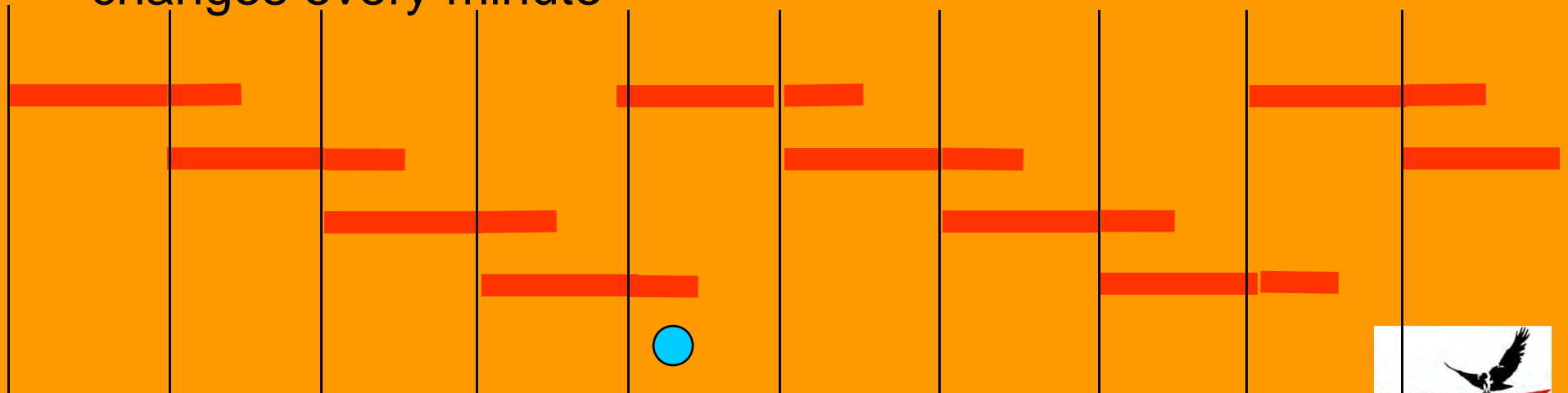

Pulse firing dramatically improves uniformity



CONVECTION

Transfer of heat by moving mass or matter.

- Pulse fire control facilitates the highest level of convective heat transfer to the furnace load.
- We have seen heat transfer efficiency improvements of over 30%.
- By firing burners at their highest exit velocity, mixing of atmosphere within the furnace chamber is maximized.
- The result is superior temperature uniformity and highest product quality.



Pulse firing dramatically improves uniformity



Hauck has applied pulse firing to many furnaces where a high degree of temperature uniformity was required at various temperatures – made possible only through pulse firing control.

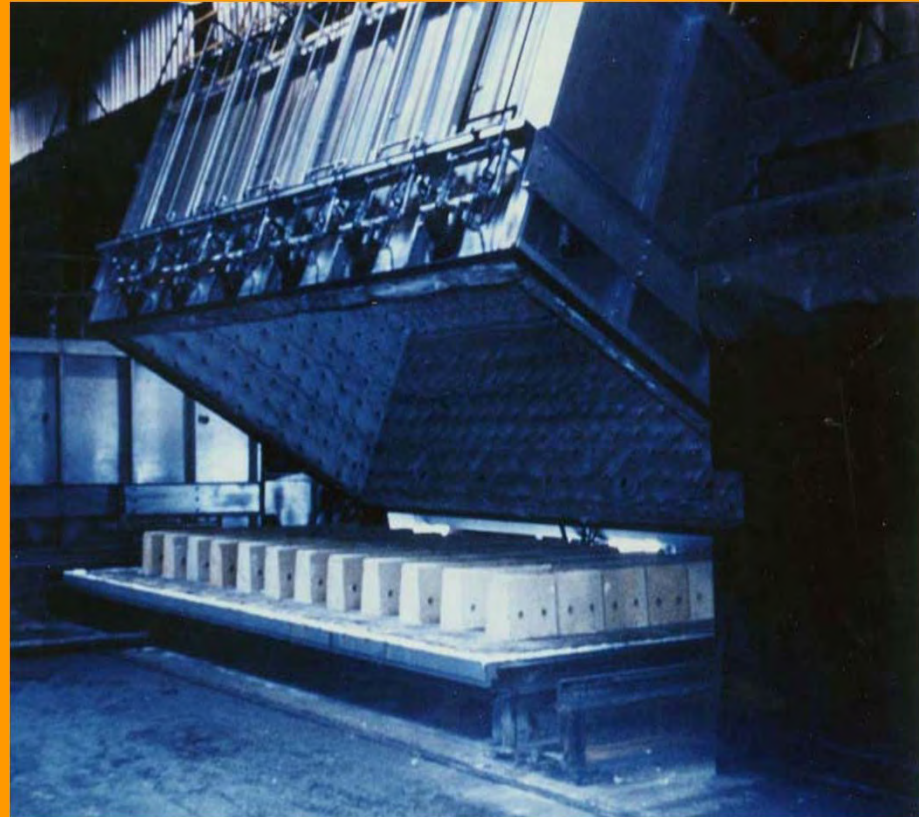

Pulse Firing and Burner Geometry

- Pulse firing control maximizes the advantages of **high velocity burners** as well as burners designed for specific flame geometries.

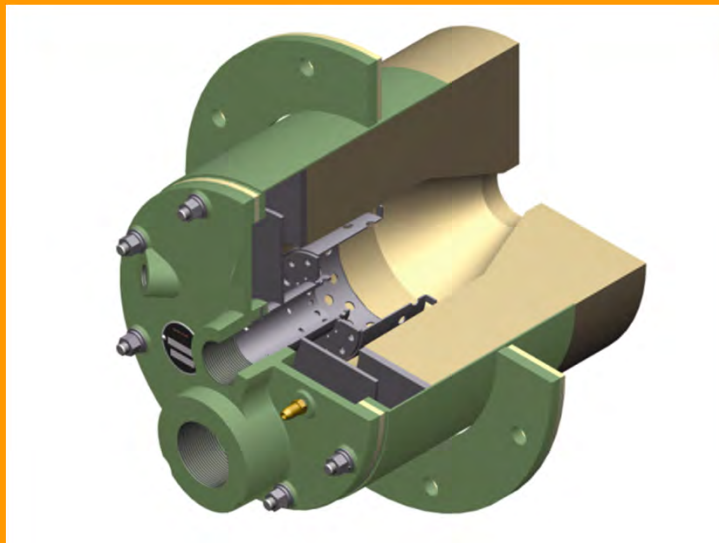

Pulse Firing and Burner Geometry

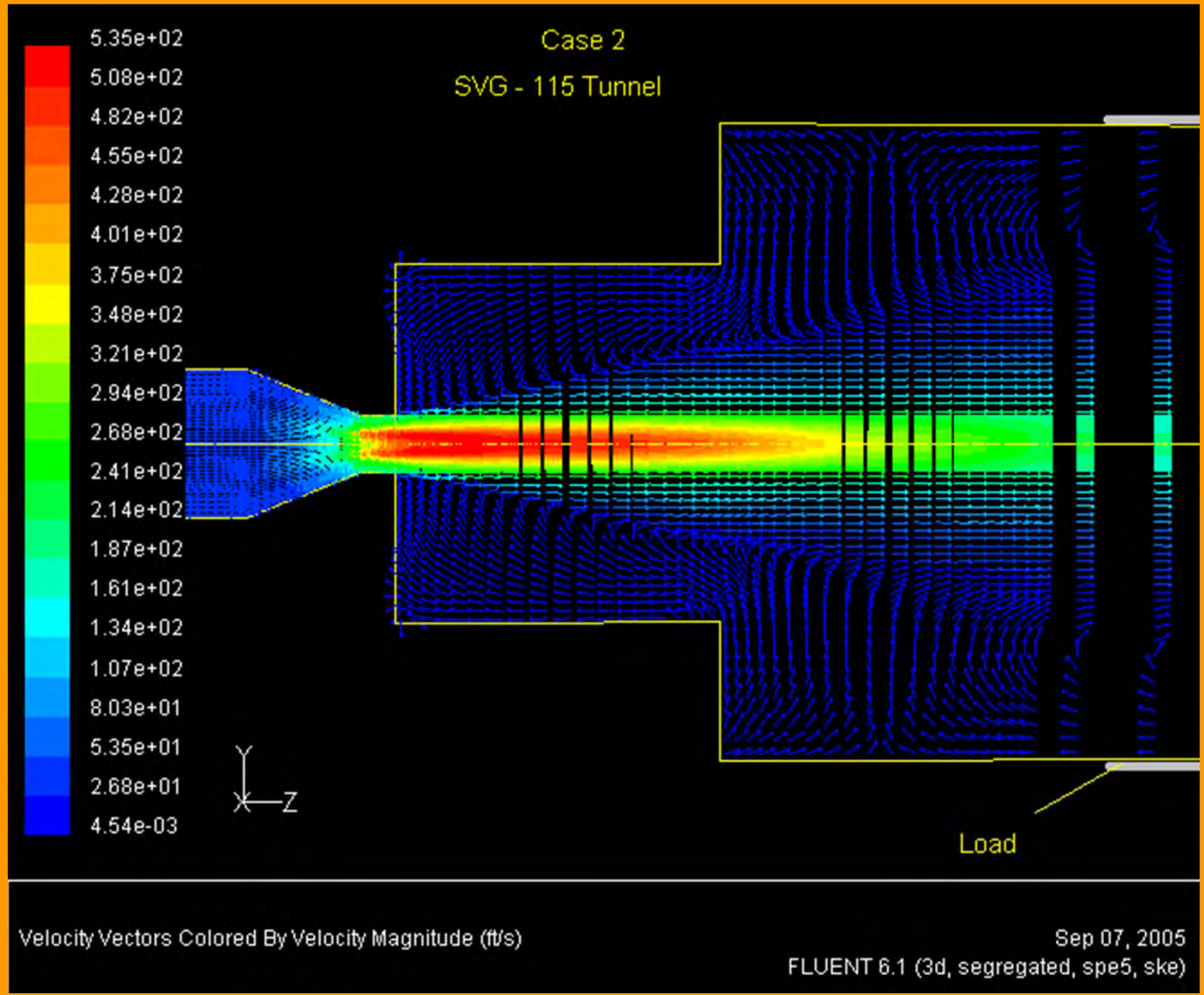

Pulse Firing reduces the requirements for excess air.

- Fuel only control keeps the velocity high to promote uniformity but uses excess air at all firing rates except 100%.
- This technique produces uniform temperatures but heats large volumes of air. \$\$\$\$\$\$

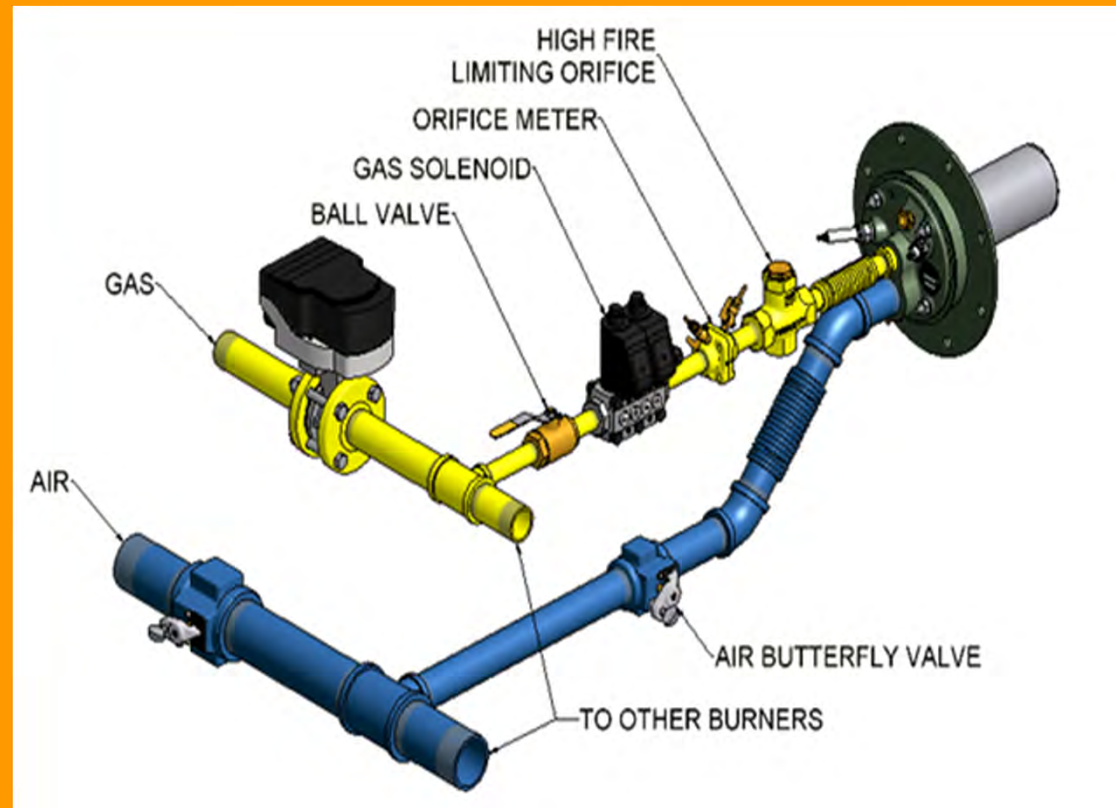

Pulse Firing reduces the requirements for excess air.



- Pulse Firing operates the burner on/off or high/low.
- When the burner is pulsed, it delivers the maximum velocity
- During off or low modes, the burner operates at an enhanced turndown, typically 20:1

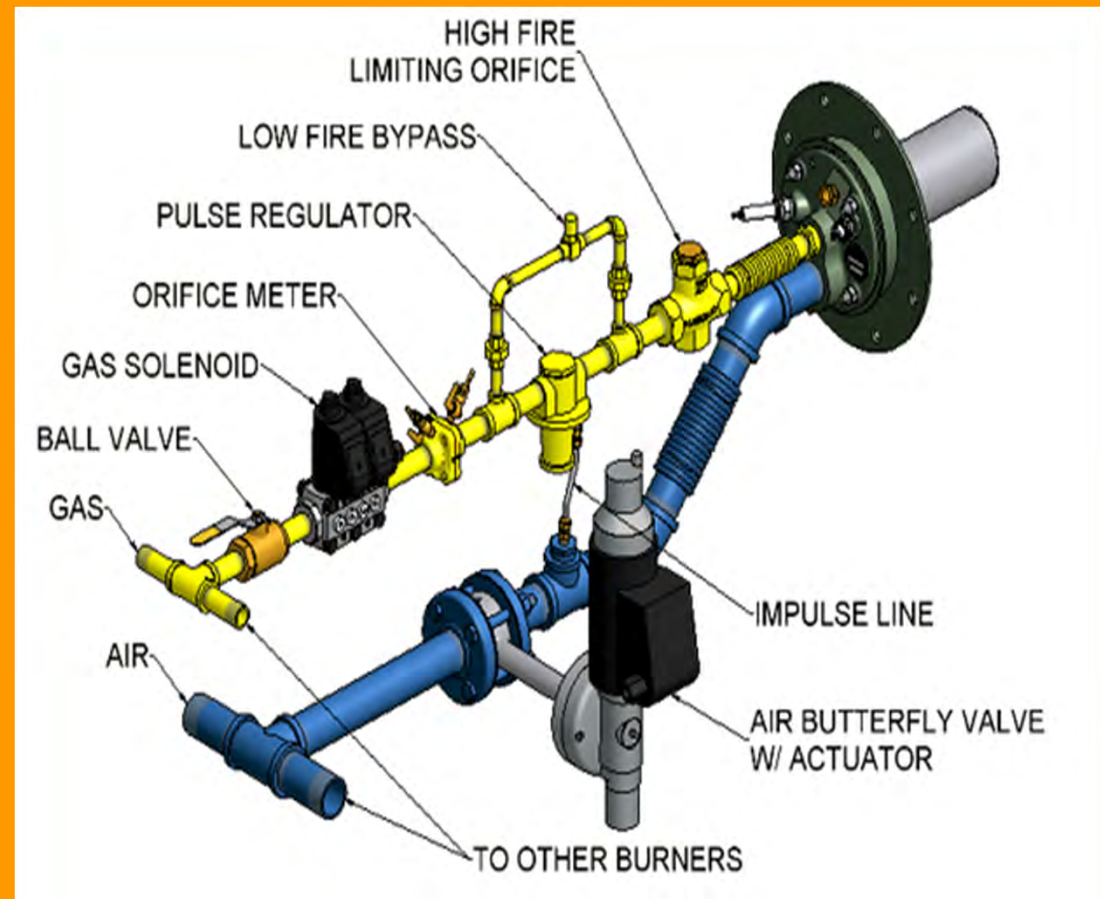

Pulse Firing reduces the requirements for excess air.



- However, there are times when excess air is required to obtain temperature uniformity at lower furnace temperatures.
- It is a method of control that Hauck calls Heat/Cool Pulse Control

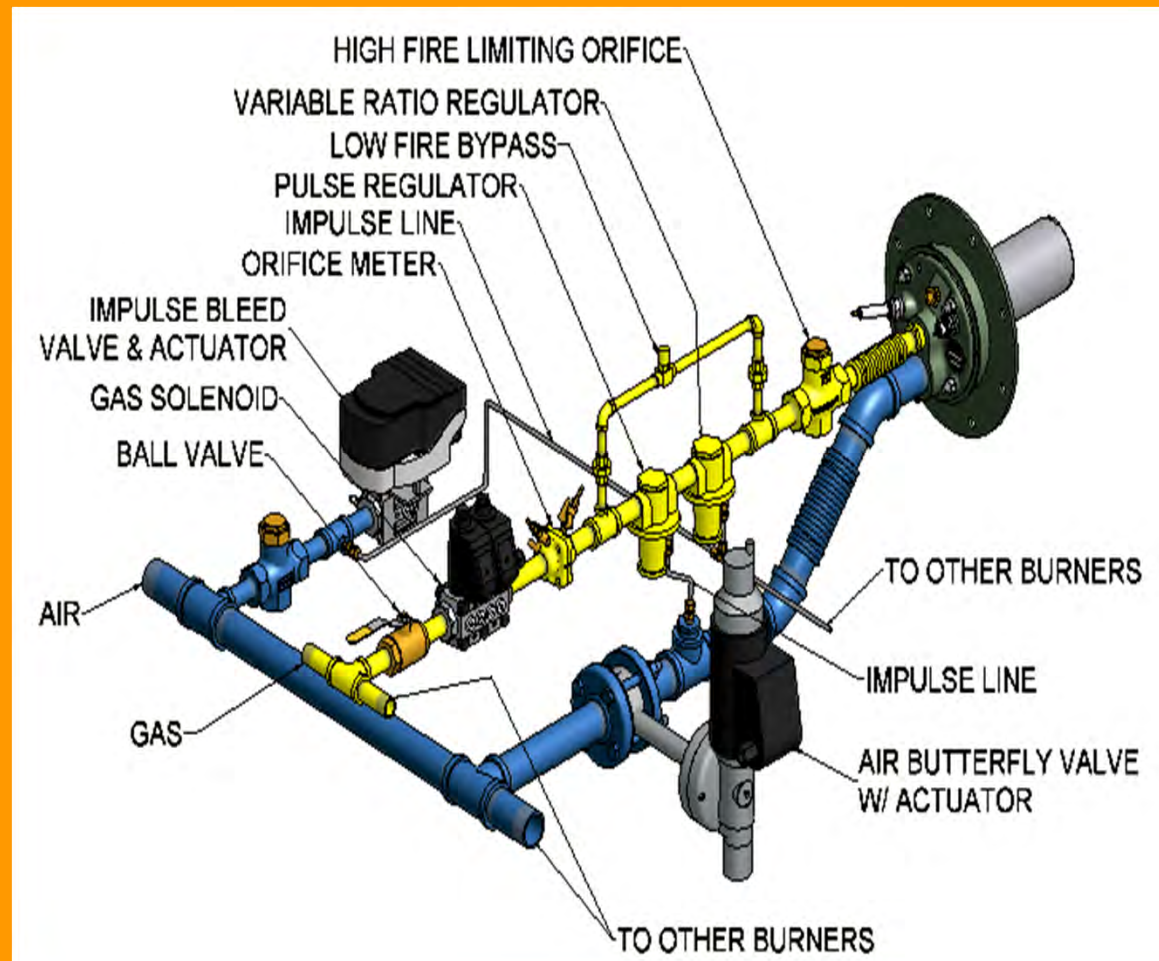

Pulse Firing reduces the requirements for excess air.



- Minimum Pulse rate 25%
- Excess air is used to satisfy temperature set point.

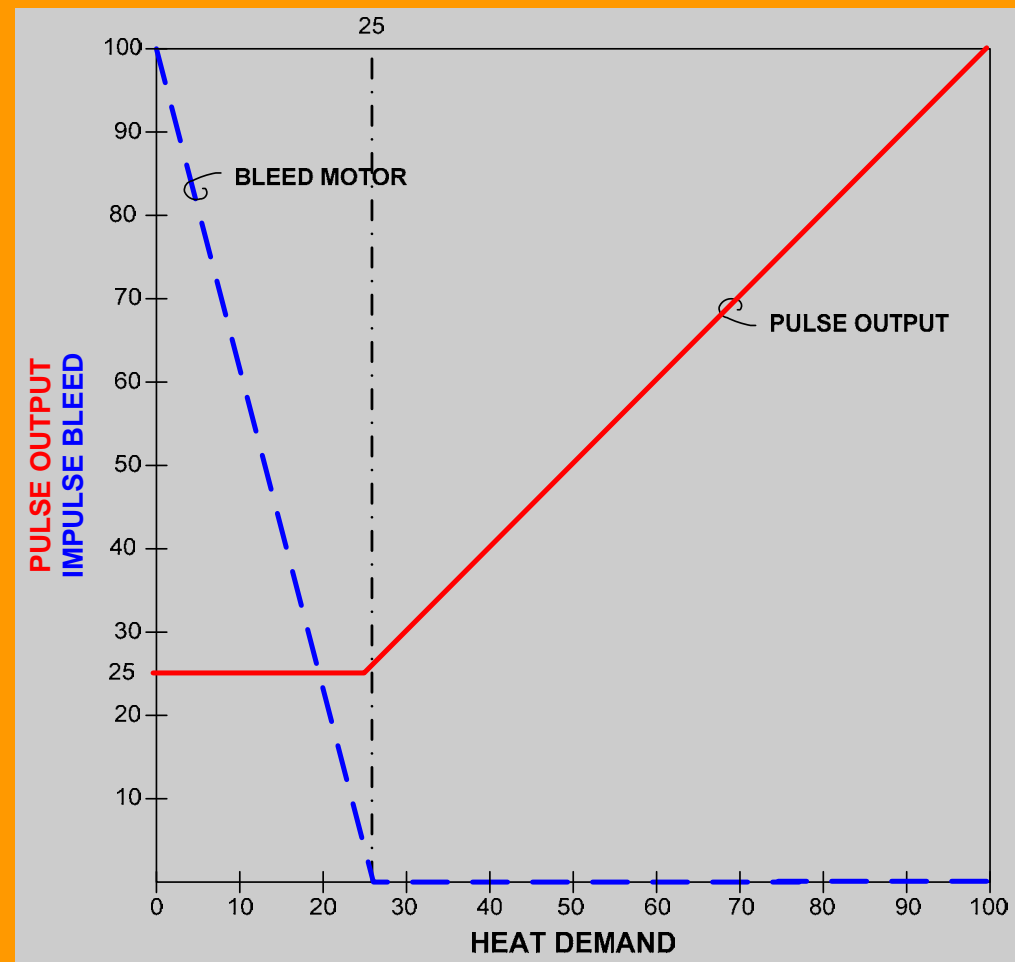

Heat/Cool Piping on a Batch Kiln



Pulse Firing simplifies combustion air and gas piping

Since the air and fuel piping to each burner is identical in pulse fired systems, changing the pulsing sequence or moving a burner from one zone to another can be done electronically as opposed to mechanically.

MODULATED CONTROL SYSTEM

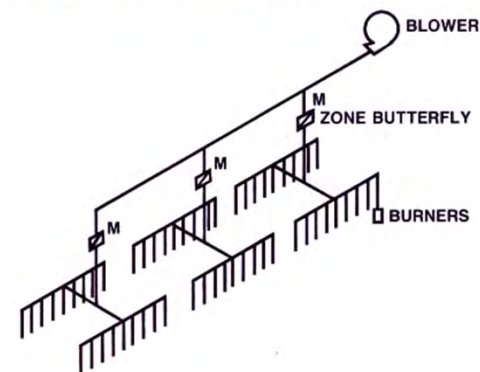

PULSE CONTROL SYSTEM

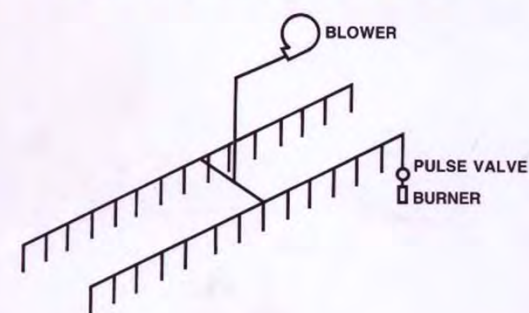



Pulse Firing and Furnace Pressure

Pulse firing does make furnace pressure control a bit more difficult, but with proper equipment and engineering this challenge is easily overcome.

- Flue sizing
- Good pressure control equipment
- For multi-flue furnace, barometric dampers in conjunction with set point controlled dampers.
- Hauck can recommend a pressure control system for your application.



Pulse Firing Advantages

- Saves fuel
 - Lowering if not eliminating the need for excess air
 - Enhances the convective heat transfer of high velocity burners
 - Faster heat-up times
- Improves the process
 - Superior temperature uniformity
 - Lowers NOx
 - Control versatility
- Advanced burner control
 - Modern burner designs are enhanced by pulse firing
 - Ease of set-up and operation and maintenance
 - Enable combustion systems to be compatible with modern computer controls and adaptable for future demands



Pulse Firing – A Visual Representation

Batch Furnace Example (via a CFD Model)

- Pulse Fire Control
- Furnace Set Point: 1800F
- 6 – SVG-125 High Velocity Burners
- Staggered arrangement above the load
- Load: 3 carbon steel rectangular ingots (10" x 10" x 72")
- Soaking stage of the heating cycle
- Heat Demand: 16%
- Burner On Time: 6 seconds



Furnace Model Geometry

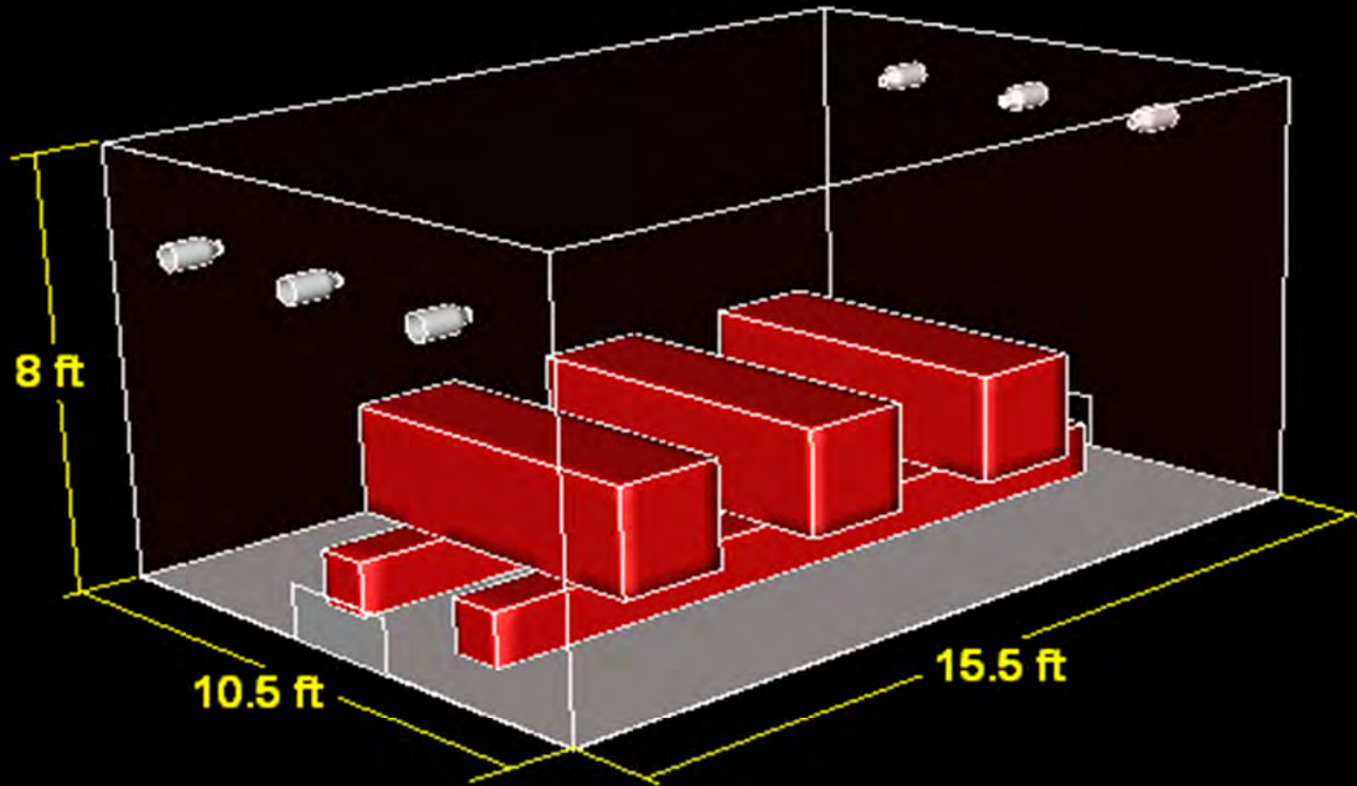

Furnace temperature in the horizontal plane of the burners during pulse firing

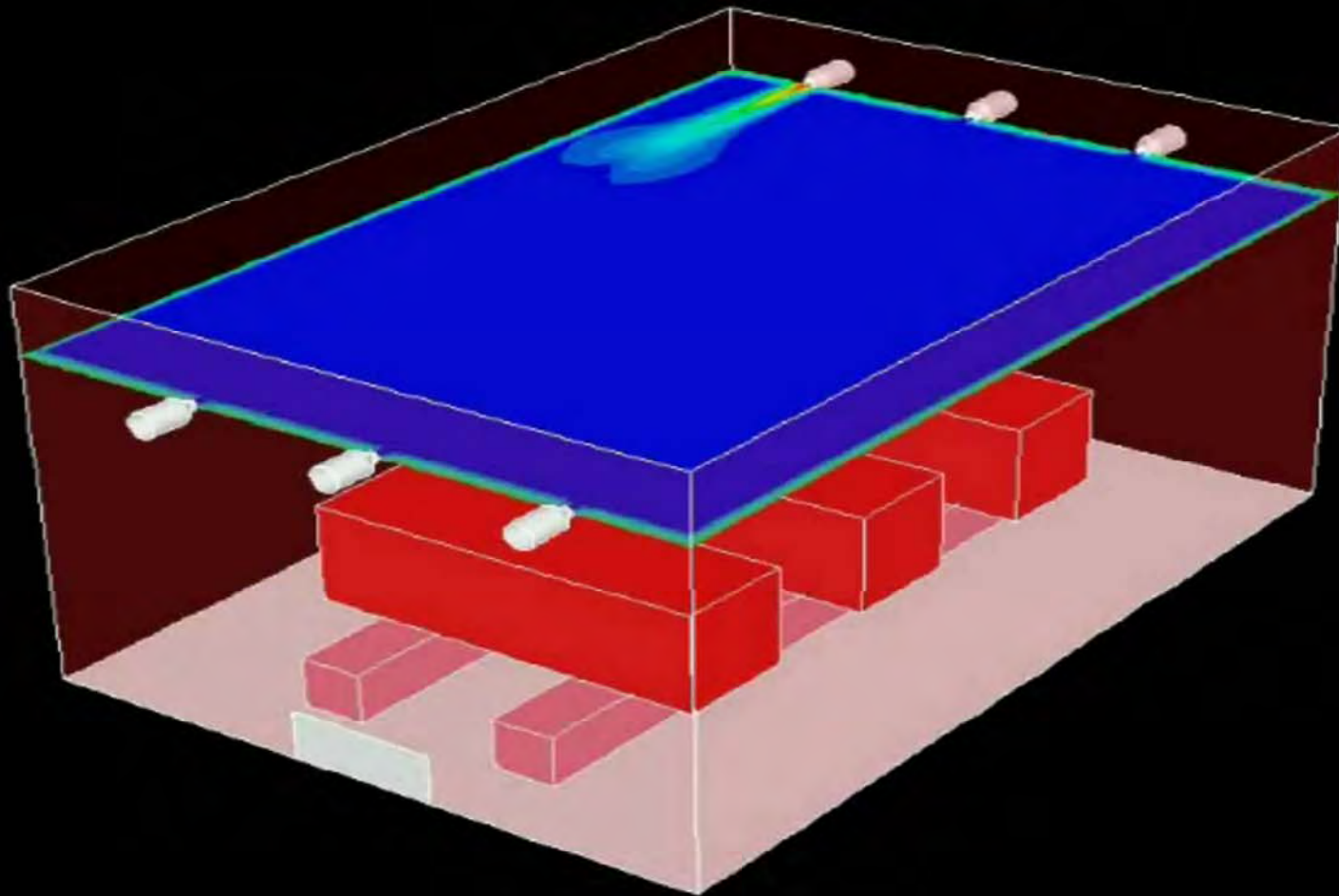

Temperature of the load while pulse firing

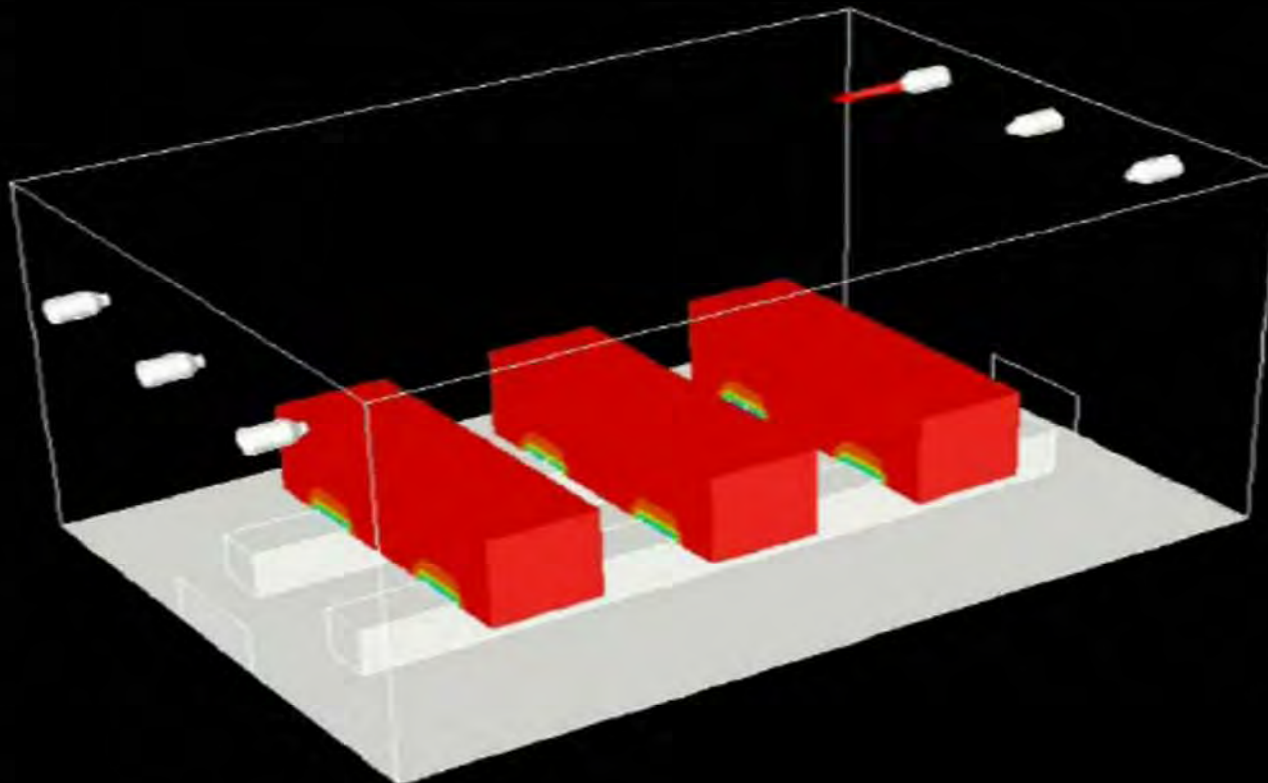
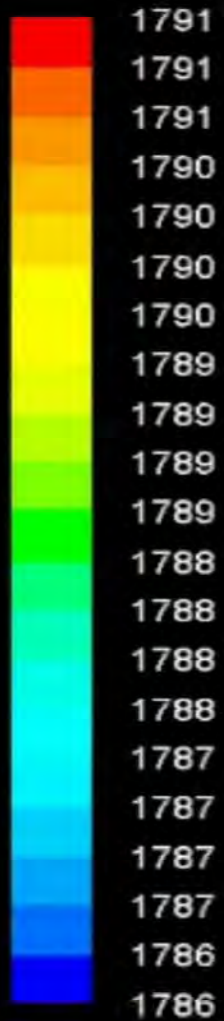

Furnace / Load Temperature Profile



Furnace Temperature Profile

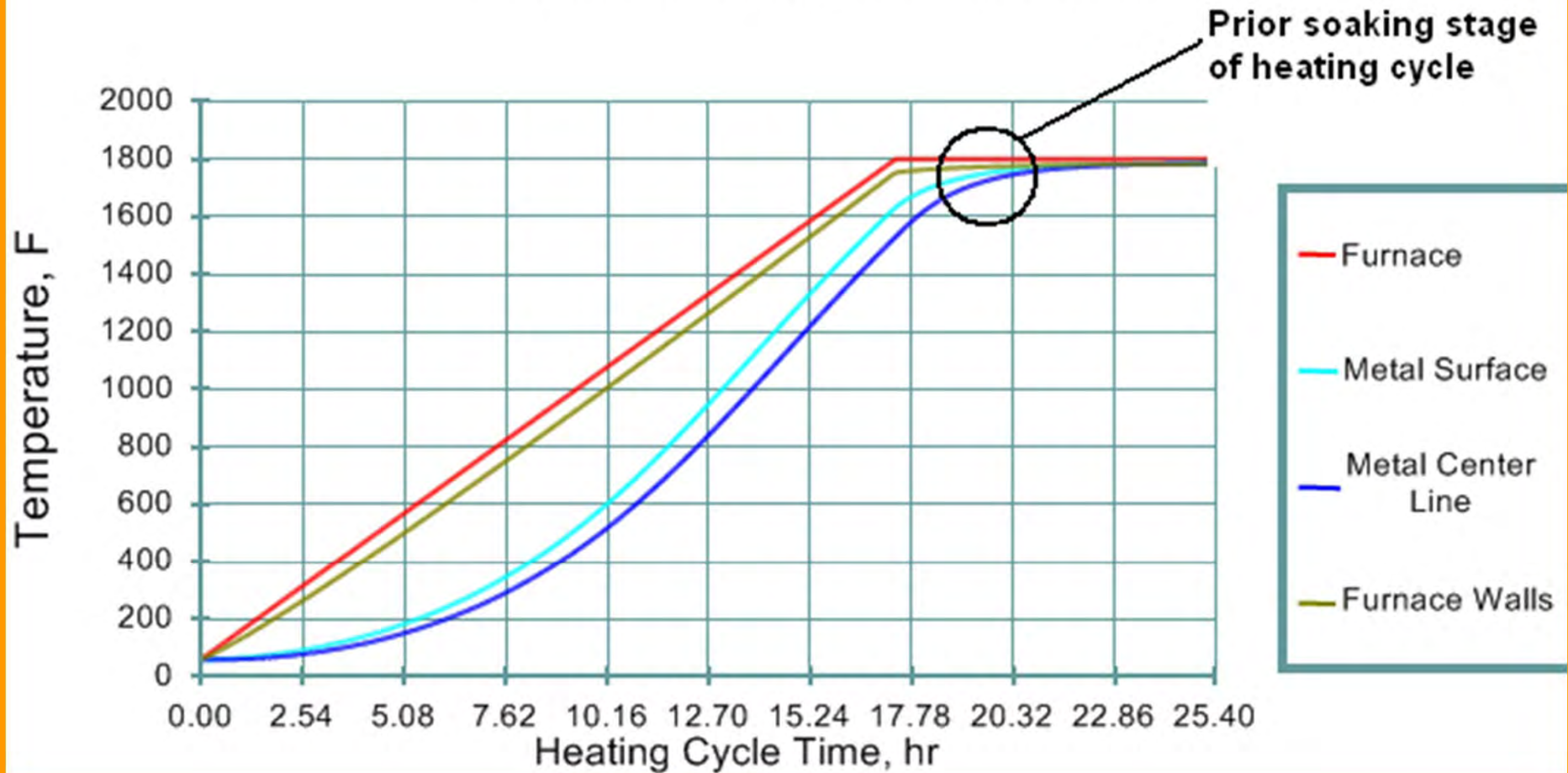

Thank You!



elster
Kromschröder